

igus[®] motion Plastics[®]

dryve D3, DC-Motor Control System

Manual V 1.1



Website Shop
www.igus.eu/D3



Videos/Tutorials
www.igus.eu/dryve/tutorial

Table of Contents

1	Safety Instructions, Protective Measures and Guidelines.....	3
1.1	Important Instructions.....	3
1.2	Qualified Personnel.....	3
1.3	Maintenance.....	3
1.4	Safety Instructions.....	4
1.4.1	Classification of Information	4
1.5	Electromagnetic Compatibility	4
2	Product Overview.....	5
2.1	Technical Data	5
2.1.1	Dimensions	5
2.1.2	Mechanical Data	5
2.1.3	Electrical Data	5
2.1.4	Environmental conditions	5
3	Installation	6
3.1	Mechanical Installation	6
3.2	Electrical Installation.....	6
3.2.1	Pin Assignment	7
4	Initial Operation.....	8
4.1	Operational Controls	8
4.2	Motor Direction.....	9
4.3	Limit Switch	9
4.4	External Motion Control.....	10
4.5	Basic Settings	10
4.5.1	Operating Modes.....	10
4.5.2	Limit Switch Control.....	11
4.5.3	Acceleration Type and Ramps	11
4.5.4	Motor Settings	13
4.5.5	Table Basic Settings.....	13
4.5.6	Speed.....	14
4.5.7	Force Setting.....	14
5	Troubleshooting.....	15
6	Accessories	15
7	Service	15

1 Safety Instructions, Protective Measures and Guidelines

1.1 Important Instructions

Read this manual carefully before operating the dryve D3 motor control system. Familiarise with the safety instructions and ensure that the required safety measures are followed.

This manual was created according to the best of our knowledge and belief. It is used for technical documentation and for assisting the user during the initial operation. The warnings, cautions and instructions issued by igus® regarding the dryve D3 motor control system must in any case be passed on to the end user if the dryve D3 motor control system is used as part of an overall system.

igus® undertakes warranties only for igus® products in accordance with the standards, norms and specifications given in this manual. The guarantee covers only the replacement or repair of a defective dryve D3 motor control system. There is no liability for consequential damage and consequential errors. igus® does not take any responsibility for the integration of the dryve D3 motor control system into the overall system. The responsibility for it lies with the plant designer or the end user. Please observe the instructions under "**Qualified Personnel**". igus® assumes no liability for personal injury or damage to property resulting from misuse or unauthorised technical modification of the dryve D3 motor control system.

igus® reserves the right to make changes and improvements to the product or the technical documentation at any time without prior notice.

The dryve D3 motor control system must only be used if:

- All information and safety instructions in this manual have been observed.
- No changes have been made to the dryve D3 motor control system and it is in a technically flawless condition.
- The operating limits that are specified in [technical data \(p.5\)](#) are complied with.
- Necessary measures, if called for, have been taken for radio interference suppression depending on the operating environment.
- All used connecting cables have been relieved of strain.

1.2 Qualified Personnel

The operation of the product must only be carried out by qualified personnel.

Personnel must:

- Have read and understood this manual and documentation on the installed motor, axis and accessories.
- Be familiar with all relevant applicable standards, provisions and accident prevention regulations.
- Be able, due to their training, to anticipate or recognise any hazards that may arise when using the control system.
- Ensure the safety of persons and objects when using the motor control system in the overall system.

1.3 Maintenance

The dryve D3 motor control system is maintenance-free.

Never open the housing of the dryve D3 motor control system independently, even in the event of a malfunction. Opening the housing will void the warranty.

1.4 Safety Instructions

1.4.1 Classification of Information

The degree and type of hazard are assigned to one of the following classes.

	DANGER!
<p>Safety instructions marked with DANGER indicate an imminently hazardous situation. A disregard of the notice inevitably leads to a serious or even fatal accident.</p>	

	WARNING!
<p>Safety instructions marked with WARNING indicate a potential hazardous situation. Failure to observe this notice is likely to result in a serious or fatal accident or property damage.</p>	

	CAUTION!
<p>Safety instructions marked with CAUTION indicate potential danger. Failure to comply with the notice may possibly result in an accident or property damage.</p>	

	NOTE
<p>Safety instructions marked with NOTE indicate a potential hazardous situation. Disregard of the notice may possibly result in property damage.</p>	

1.5 Electromagnetic Compatibility

	WARNING!
<ul style="list-style-type: none"> Risk of injury due to interference with signals and devices <p>Disturbed signals can cause unforeseen device reactions. Carry out the wiring in accordance with the EMC measures. Failure to follow these instructions can result in death, serious injury, or material damage</p>	

	Measures for EMC	Effect
Device assembly	Use cable clamps for the shield support, connect metal parts over a large area.	Good conductivity due to surface contact.
	Switching devices such as contactors, relays or solenoid valves with interference suppression units or spark suppressors (e.g. diodes, varistors, RC elements)	Reduce mutual interference couplings.
Wiring	Keep cables as short as possible.	Avoid capacitive and inductive interference.

2 Product Overview

Ready to use immediately

Connect the voltage source and the motor: you are ready to start. No complicated software installation or complex wiring of various additional switches and sensors.

Easy control

The intuitively operated rotary elements allow you to set the speed and force limit of the connected motor without prior knowledge. A travel movement can be started by the two buttons on the front of the dryve D3.

2.1 Technical Data

2.1.1 Dimensions

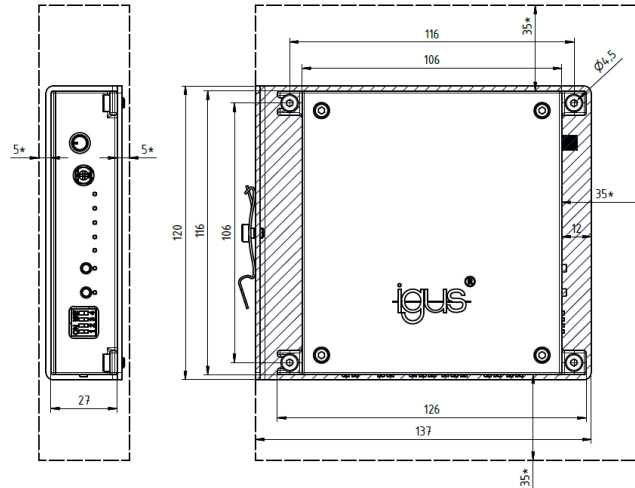

The hatching indicates the distance for neighbouring components.

2.1.2 Mechanical Data

D x W x H dryve D3 in mm	116 x 27 x 126
Weight	150 g
D x W x H angle adapter in mm	137 x 30 x 120
Weight	315 g

2.1.3 Electrical Data

Voltage supply	24 V, ± 2 V	
Motor types	DC motor	
Continuous motor current	Max. 2.5 A	
Motor output frequency	Switch 4 off	8 kHz
	Switch 4 on	1 kHz
Power output	Max. 60 W	
Cable lengths	Max. 3 m	
Cable cross-sections	0.34 mm ² to 1.5 mm ²	
Limit switch	Voltage	U _B at X2.1
	Current	Max. 10 mA
External travel movement	Voltage	5 V
	Current	5 mA

2.1.4 Environmental conditions

Ambient temperature	Operation	-20 °C to +45 °C
	Transport	-40 °C to +60 °C
	Bearing	-40 °C to +60 °C
Relative humidity	≤ 90 %, non-condensing	
Protection class	IP 30	
Degree of soiling according to EN 61010	1	

3 Installation

3.1 Mechanical Installation

	WARNING!
<ul style="list-style-type: none"> • Danger of malfunction • Fire hazard • Explosion hazard <p>Never operate the dryve D3 motor control system in water or in an aggressive, flammable or explosive atmosphere. Always pay attention to the environmental conditions (p.5)</p>	

- Installation in a switch cabinet can be done on a TS 35 support rail (EN 50022) by mounting on the separately available angle adapter.
- The installation site must be free of extreme vibrations or shocks.
- The dimensions for adjacent components can be found in the drawing at [dimensions \(p.5\)](#)
- The heated air flow of other devices and components must not be led through the area of the dryve D3.

3.2 Electrical Installation

The dryve D3 motor controller is constructed for use with direct currents.
Every voltage mentioned in this manual can be regarded as direct current.

	WARNUNG!
<ul style="list-style-type: none"> • Risk of sudden movements <p>To ensure that the dryve D3 can be operated without interference, the voltage supply must not be executed as a PELV wiring (Protection by Extra Low Voltage- primary safety earth potential connected to secondary ground).</p>	

	WARNING!
<ul style="list-style-type: none"> • Risk of injury <p>Make sure that an emergency shutdown can be performed at all times.</p>	

	CAUTION!
<ul style="list-style-type: none"> • Danger of electrical voltage • Danger of electric arcs <p>Always turn off the power before disconnecting or making electrical connections in the system. Secure the power supply against restart.</p> <p>After switching the device off, wait at least 5 minutes. Check for the absence of voltage before working on the system.</p> <p>Danger of improperly mounted electrical connections.</p> <p>Do not allow cables to be unmounted and ensure that all connections are secure.</p>	

	CAUTION!
<ul style="list-style-type: none"> • Electromagnetic alternating fields <p>Electromagnetic fields around the live wires may cause interference. Lay the supply and motor cables separately from the control cables. Use the shortest possible cable lengths. Follow the instructions for electromagnetic compatibility (p.5)</p>	

NOTE
<p>An operating voltage above the voltage specified in the technical data, as well as a voltage reversal might destroy the dryve D3 motor control system.</p> <p>Select an operating voltage within the voltage range specified in the technical data.</p>

3.2.1 Pin Assignment

The connectors must be wired according to your application. For this purpose, use the detailed illustrations below for each individual connector.

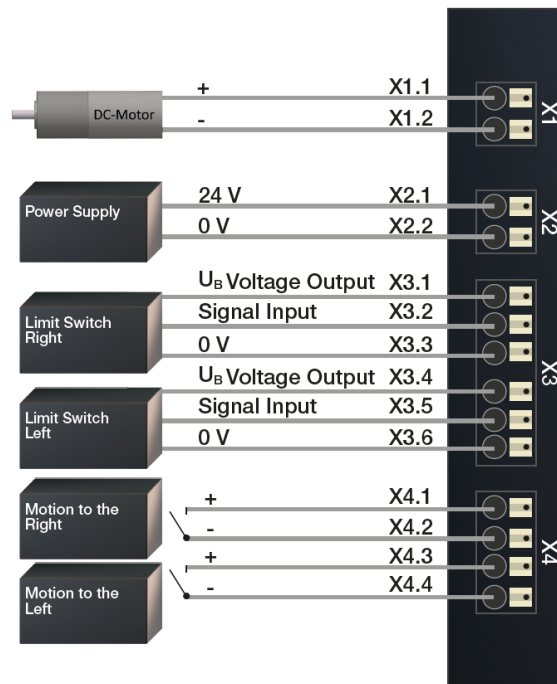

The terminals are connected as follows:

1. Insulate the cores over a length of 8 mm
2. Press the white spring of the core opening by hand or with a screwdriver into the terminal block.
3. Push the core deep into the opening.
4. Remove the white spring out of the connector again.

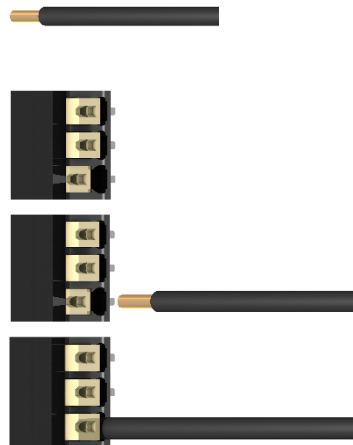

4 Initial Operation

The following describes the initial operation, which makes the start easy.

You can find informative videos on the initial operation at igus.eu/D3

Interconnect the whole system according to [EMC guideline \(p.4\)](#)

Minimum equipment

To control a motor with the D3 drive, a minimum equipment has to be provided by the user:

1. Voltage source with 24 V and connecting cables
2. Motor with suitable cable

	DANGER!
<ul style="list-style-type: none"> • Danger of falling load <p>Never work under unsecured vertical axes and loads. Secure the axis or load against falling by a mechanical safety device or other approved safety method.</p>	

	WARNING!
<ul style="list-style-type: none"> • Fire hazard <p>Faulty settings of the drive D3 motor control system can lead to extremely high motor temperatures.</p>	

NOTE	
A faulty connection can damage or destroy the drive D3 or drive.	

4.1 Operational Controls

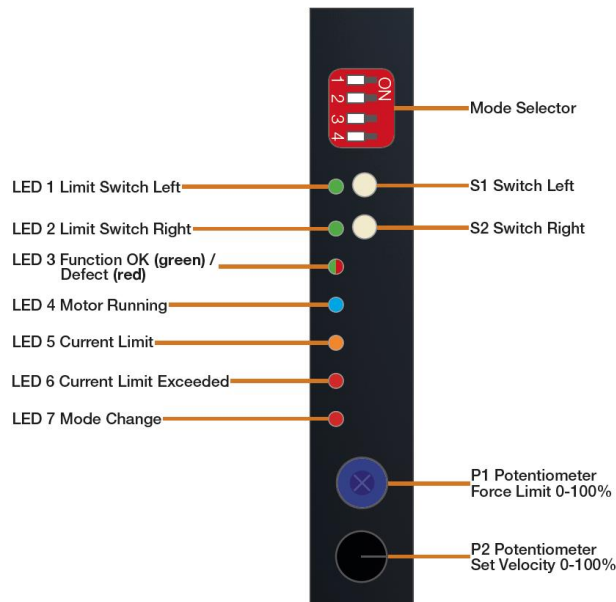

4.2 Motor Direction

For a proper operation, it is necessary that the motor rotates in a defined direction. For determination, please use the following procedure:

1. View onto drive shaft
2. Actuation of the button S2 for clockwise rotation
3. Clockwise rotation corresponds to a right-hand rotation

If the motor rotates counter clockwise, the polarity of the motor connecting cables must be changed.



4.3 Limit Switch

Two different types of limit switches can be connected to the dryve D3.

- Passive mechanical switches with NC functionality (NC - Normally Closed)
- Active electronic proximity switches with NC functionality (NC - Normally Closed), **PNP** characteristics

Connected limit switches are supplied with the same voltage as supplied to X2.1. For both types, different connection options must be considered.

Mechanical switches

The switches are connected to a voltage output and the respective signal input. The right limit switch is connected to X3.1 and X3.2, the left to X3.4 and X3.5.

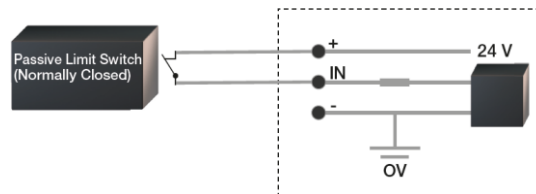

Electronic switches

The switches must be connected to a voltage output, the signal input and 0 V respectively.

The supply voltage of the right limit switch is connected to X3.1, the output signal to X3.2 and 0 V to X3.3. The supply voltage of the left limit switch is connected to X3.4, the output signal to X3.5 and 0 V to X3.6.

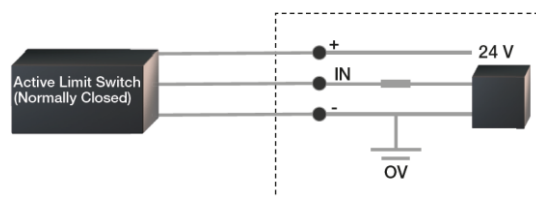

To guarantee a logical and safe function, the limit switches must be assigned correctly to the respective running direction. A correctly connected, not set limit switch is indicated by a green LED below the respective direction button.



If a limit switch is set, the LED below the respective direction button goes out. Please check that the LED 1 below the button "S1 left" turns off if the left limit switch is set. A test can be executed without driving the motor. If the connections are not correct, the positions of the limit switches must be interchanged.

4.4 External Motion Control

Movements can be remotely controlled via an external wiring.

For this purpose, normally-open (NO) passive switching contacts are connected to X4.1 and X4.2 as well as X4.3 and X4.4. These switching contacts can be push buttons, relays and optocouplers. A higher-level control system can be used via potential-free contacts. The function is identical to the function of the buttons S1 and S2.

If a button combination for left-hand/right-hand rotation with only 3 connecting wire is used, X4.2 and X4.4 must be bridged. The common wire of the button combination must be connected to these bridged connections. The buttons for left and right are connected to X4.1 and X4.3 respectively

NOTE

No external potential must be connected to X4 as this may destroy the dryve D3.

4.5 Basic Settings

In its delivery condition, all switches are set to "off" (down position).

4.5.1 Operating Modes

Tip mode



The motor is moved to the left or right when button S1 or S2 is pressed. If the button is not pressed, the motor stops.

Start to end mode



The motor is moved to the left or right after pressing button S1 or S2.

The motor stops only when:

1. One of the two buttons are pressed
2. The movement encounters a block whose resistance is greater than the [force \(p.14\)](#) the motor is allowed to apply
3. The [limit switch \(p.9\)](#) at the end of the movement direction is triggered

4.5.2 Limit Switch Control

Limit switch



A travel movement is automatically stopped if:

1. The limit switch is triggered in the direction in which the movement is executed
2. The movement encounters a block whose resistance is greater than the [force \(p.14\)](#), the motor is allowed to apply

Block travel



A travel movement is automatically stopped if:

1. The movement encounters a block whose resistance is greater than the [force \(p.14\)](#), the motor is allowed to apply

NOTE

This operating mode is only suitable for drives/motors which, due to their own torque, cannot damage the mechanical structure of the axis! Powerful drives with incorrectly adjusted force limitation, may damage or destroy the mechanical structure of the axis! The suitability can be resolved by checking the motor data sheet and the axis parameters.

In this mode, the motor travels until the set force is reached (P1 force limit) and then shuts off. For this reason, it is important that the [force limitation \(p.14\)](#) is set correctly.

4.5.3 Acceleration Type and Ramps

The maximum achievable acceleration depends on the connected motor, a possible mounted gearbox and the connected linear or rotary axis as well as on the load to be moved.

Basically, the deceleration cannot be influenced by the settings of the dryve D3. This is determined by the mechanical properties of the combination of the motor, a possible mounted gearbox and the connected linear or rotary axis and the load to be moved.

Maximum acceleration



The motor is maximally accelerated to the pre-set speed.

Acceleration ramps



The motor is accelerated according to the selected ramp.

It is possible to set 5 different accelerations.
In the delivery state, the acceleration ramp 3 is set.

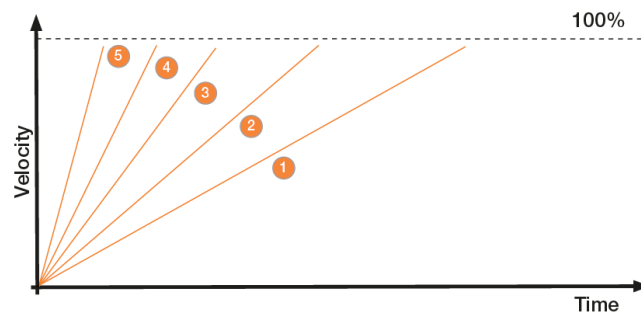

Setting the acceleration:

1. Initiation of the acceleration change mode by simultaneously pressing buttons S1 and S2 for at least 5 seconds (LED 7 lights up red) -> LEDs 4 to 7 flash 5 times.



2. Release both buttons
3. LED 7 flashes at intervals -> number of flashes represents the set acceleration ramp
4. Change the acceleration by pressing button S1 until LED 4 "Motor running" lights up



5. Release the button S1 -> The next acceleration is set and LED 7 flashes repeatedly corresponding to the selected acceleration ramp number
6. After acceleration ramp 5, acceleration ramp 1 is repeated
7. To exit the acceleration ramp change mode, press the S2 button for at least 3 seconds -> the LEDs 4 to 7 flash 5 times



Initial set up videos available at www.igus.eu/dryve/tutorial and igus.eu/D3.

4.5.4 Motor Settings

DC motors with low inductances



If the operating mode for highly inductive motors is used with this type of motor, it can lead to an increased noise level as well as not reaching the maximum speed.

DC motors with high inductances



If the operating mode for low inductive motors is used with this type of motor, it can lead to an increased noise level as well as not reaching the maximum speed.

4.5.5 Table Basic Settings

Basic Settings	Dip switch	Function
Operating modes		Tip mode
		Start to end mode
Limit switch control		Limit switch
		Block travel
Acceleration		Maximum acceleration
		Acceleration ramps
Motor settings		Low inductances
		High inductances

4.5.6 Speed

The motor speed can be adjusted continuously from 0% to 100% via the potentiometer P2. At 50% of the achievable speed, a lock is available for more precise settings.

The maximum achievable speed depends on the connected motor, a possible mounted gearbox and the connected linear or rotary axis as well as the load to be moved.

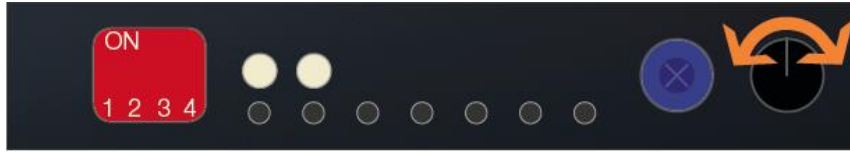

4.5.7 Force Setting

The maximum force of the drive, i.e. the maximum current output, should always be set correctly to suit the respective mechanical structure. This also applies to the use of limit switch operation.

To determine and test the ideal setting for the limitation, select the operating mode [Tip mode \(p.10\)](#) and the maximum [acceleration \(p.11\)](#).

Setting the optimal force limit:

1. Turn the potentiometer for force limit P1 and the setpoint speed P2 clockwise to the end stop
2. Move the connected motor, including the load, in a free direction



3. Reduction of the permissible force by a counter clockwise rotation to the end stop of the potentiometer P1
4. The current limit LED 5 (yellow) lights up and the over current LED 6 (red) flashes

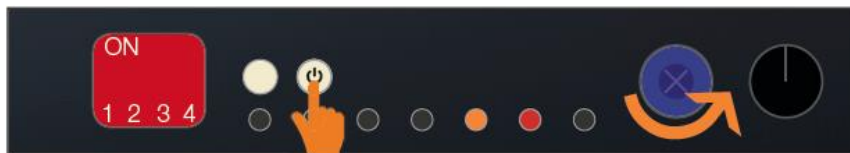

5. Increase the force limitation in small steps by turning the potentiometer P1 clockwise till LED 5 (yellow) and LED 6 (red) will turn off permanently
6. Run the motor across the whole axis in both directions

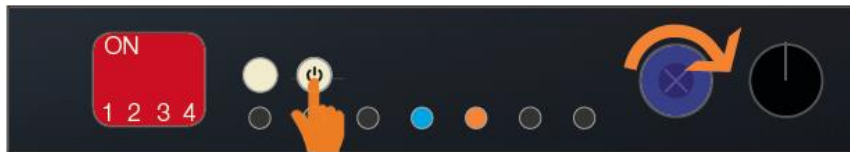

7. The motor moved across the whole axis and LED 5 (yellow) lights up for a less than a 1 second.
The force setting is applied successfully.
If the motor doesn't move across the whole axis, please proceed with step 8
8. The Motor stops prior to reaching the axis end, LED 5 (yellow) lights up for 1 second, the Motor Running LED 4 (blue) turns off and LED 6 (red) lights up permanently.
Increase the force limit P1 in small steps. Please proceed with step 6

Optional settings "Start to end mode"

9. Force setting Re-test. If the motor is not able to be moved across the whole axis the force limit P1 must be increased in small steps. Please proceed with step 6
10. When the motor is being blocked at the axis end, the LED 5 (yellow) lights up a 1 second, LED 4 (blue) will turn off and LED 6 (red) will light up constantly.
The force setting is applied successfully.
If LED 4 (blue) stays on the whole time the force limit P1 is set to high. Please proceed with step 11
11. Decrease the fore limit P1 in small steps. Please proceed with step 6. Switching to "Tip Mode" is not necessary

5 Troubleshooting

Problem	Description	Remedy
The motor control system does not perform any movements	When the buttons S1 or S2 are actuated, a colour change of the LED 3 from green (function OK) to red (defect) is to be observed	Please contact customer service

6 Accessories

AK-DCCON-D3-0001 Top-hat rail mounting adapter kit

7 Service

Customer service

dryve@igus.de

+49 (0) 2203-9649-845

Technical support for igus dryve motor control systems

Videos/Tutorials

www.igus.eu/dryve/tutorial

Video guides explaining the functional range and the set up of the dryve D3
Additional product videos



Website Shop

<http://www.igus.eu/D3>

Download the dryve D3 firmware, manual and specifications
Ordering of further motor control systems



Website drylin E

www.igus.eu/drylinE

Download data sheets of the electric drive technology
Ordering of motors, limit switches and other accessories

Website drylin drive technology

www.igus.eu/drivetechology

Download data sheets of the mechanical drive technology
Ordering of axes, linear robots and accessories

Contact

www.igus.eu

info@igus.eu

+49 (0) 2203-9649-0

Imprint

All rights reserved:

igus® GmbH

Spicher Str. 1a

51147 Cologne, Germany

© 2018